

# GENARO

2023

Wohn- und Esszimmersystem

*Living and dining room system*



**medium**<sup>®</sup>  
Raum für Werte

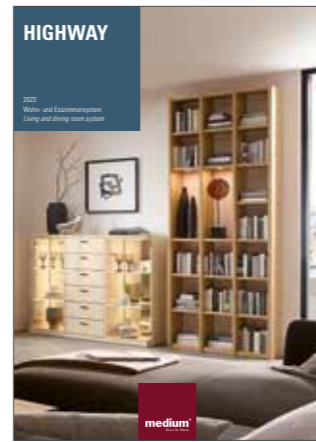
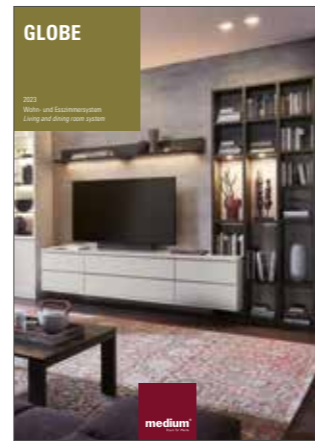

Planungsbeispiele *Planning examples*

4–29

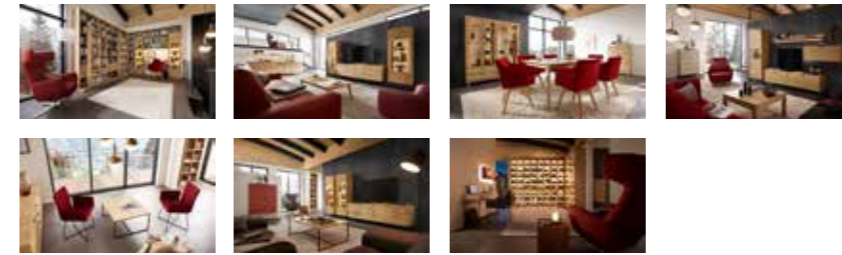

4–19



20–27



28–29

Exterior – stilgebende Elemente *Exterior – style elements*

Material, Oberfläche & Farbe *Materials, finish & colour*

30–32

Griffe *Handles*

31

Stoff- und Lederkollektionen *Upholstery collections*

32

Beispielartikel *Sample articles*

33

Interior – Komfort und Ausstattung *Interior – Comfort and features*

34–35

Legende *Legend*

Breite *Width*



Höhe *Height*



Tiefe *Depth*



Lack matt *Lacquer matt*



Lack hochglänzend *High-gloss lacquer*



Holz *Wood*



Stoff *Fabric*



Leder *Leather*



Griff *Handle*



Klarglas *Clear glass*



Satiniertes Glas *Frosted glass*





















## 4-5

- 68051/ Eckregalkombination *Corner shelf combination*  
 69529 350,5×298,0 cm 250,9 cm 55,2 cm / 49,2 cm  
 OA – Asteiche *Knotty oak*
- 93743 Stuhl R3 *Chair R3*  
 56,0 cm 82,5 cm 59,0 cm  
 OA – Asteiche *Knotty oak*   
 4A – Velours *Velours Cloud Ember*

## 6-7

- 68049 Sideboard *Sideboard*  
 258,2 cm 85,3 cm 49,2 cm  
 OA – Asteiche *Knotty oak*   
 R4 – Lack Cashmere *Cashmere lacquer*   
 H8 – Schwarz matt *Black matt*
- 75902 Wandbord *Wall shelf*  
 165,0 cm 8,2 cm 20,6 cm  
 OA – Asteiche *Knotty oak*
- 69499 Wohnkombination *Living room combination*  
 363,2 cm 179,2 cm 49,2 cm  
 OA – Asteiche *Knotty oak*   
 R4 – Lack Cashmere *Cashmere lacquer*   
 H8 – Schwarz matt *Black matt*
- 92454 Couchtisch *Coffee table*  
 120,0 cm 41,3 cm 75,0 cm  
 OA – Asteiche *Knotty oak*

## 8-9

- 68010 Vitrine *Display cabinet*  
 153,2 cm 190,9 cm 39,6 cm  
 OA – Asteiche *Knotty oak*   
 R4 – Lack Cashmere *Cashmere lacquer*   
 H8 – Schwarz matt *Black matt*
- 6× 93743 Stuhl R3 *Chair R3*  
 56,0 cm 82,5 cm 59,0 cm  
 OA – Asteiche *Knotty oak*   
 4A – Velours *Velours Cloud Ember*
- 92459 Esstisch *Dinner table*  
 180,0 cm 75,4 cm 95,0 cm  
 OA – Asteiche *Knotty oak*
- 76619 Korpuselement *Carcass element*  
 78,2 cm 120,5 cm 39,6 cm  
 OA – Asteiche *Knotty oak*   
 H8 – Schwarz matt *Black matt*

## 10-11

- 30380 Korpuselement *Carcass element*  
 75,0 cm 120,5 cm 39,6 cm  
 OA – Asteiche *Knotty oak*   
 R4 – Lack Cashmere *Cashmere lacquer*   
 H8 – Schwarz matt *Black matt*
- 90300 Couchtisch *Coffee table*  
 75,0 cm 41,3 cm 75,0 cm  
 OA – Asteiche *Knotty oak*
- 69607 Wohnkombination *Living room combination*  
 60,0/225,0 cm 190,9 cm 49,2 cm  
 OA – Asteiche *Knotty oak*   
 R4 – Lack Cashmere *Cashmere lacquer*   
 H8 – Schwarz matt *Black matt*

## 12-13

- 83747 Couchtisch *Coffee table*  
 120,0 cm 39,6 cm 75,0 cm  
 OA – Asteiche *Knotty oak*
- freie Sideboard *Sideboard*  
 Planung 213,2 cm 67,7 cm 39,6 cm  
 OA – Asteiche *Knotty oak*   
 H8 – Schwarz matt *Black matt*
- 76317 Regal *Shelf*  
 59,0 cm 250,9 cm 26,4 cm  
 OA – Asteiche *Knotty oak*
- 93743 Stuhl R5 *Chair R5*  
 56,0 cm 82,5 cm 59,0 cm  
 OA – Asteiche *Knotty oak*   
 4A – Velours *Velours Cloud Ember*

## 14-15

- 69814 Korpuselement *Carcass element*  
 93,2 cm 139,7 cm 39,6 cm  
 R8 – Lack Oxidrot *Oxide red lacquer*   
 H8 – Schwarz matt *Black matt*
- 69813 Regal *Shelf*  
 68,7 cm 260,0 cm 26,4 cm  
 OA – Asteiche *Knotty oak*
- 83747 Couchtisch mit Kufen *Coffee table with runners*  
 120,0 cm 39,6 cm 75,0 cm  
 OA – Asteiche *Knotty oak*
- 69805 Wohnkombination *Living room combination*  
 363,2 cm 190,9 cm 49,2 cm  
 OA – Asteiche *Knotty oak*   
 H8 – Schwarz matt *Black matt*

## 16-17

- 69811 Eckregalkombination *Corner shelf combination*  
 303,2×153,2 cm 250,9 cm 49,2 cm  
 OA – Asteiche *Knotty oak*   
 H8 – Schwarz matt *Black matt*
- 83276 Funktionstisch *Functional table*  
 123,2 cm 77,5 cm 39,6 cm  
 OA – Asteiche *Knotty oak*   
 Push to open *Push to open*
- 93808 Stuhl R5 mit Kreuzgestell *Chair R5 with criss-cross base*  
 59,0 cm 88,0 cm 56,5 cm  
 1I – Leder *Leather Hermes Nero*

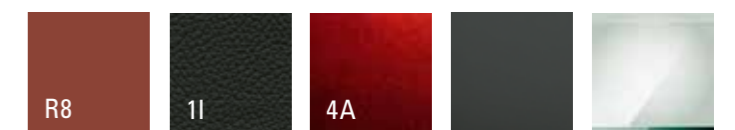









## 20-21

- 68019 Wohnkombination *Living room combination*  
 ↳ 363,2 cm ↳ 190,9 cm ↳ 49,2 cm  
 ES – Eiche Sand *Sand oak*  
 P6 – Lack Taupe *Taupe lacquer*  
 H4 – Chrom glänzend *Shiny chrome*
- 92454 Couchtisch *Coffee table*  
 ↳ 120,0 cm ↳ 41,3 cm ↳ 75,0 cm  
 ES – Eiche Sand *Sand oak*  
 P6 – Lack Taupe *Taupe lacquer*
- 68022 Sideboard *Sideboard*  
 ↳ 243,2 cm ↳ 102,9 cm ↳ 49,2 cm  
 ES – Eiche Sand *Sand oak*  
 P6 – Lack Taupe *Taupe lacquer*  
 H4 – Chrom glänzend *Shiny chrome*

## 22-23

- 76620 Korpuselement *Carcass element*  
 ↳ 93,2 cm ↳ 120,5 cm ↳ 39,6 cm  
 ES – Eiche Sand *Sand oak*  
 H4 – Chrom glänzend *Shiny chrome*
- 92459 Esstisch *Dinner table*  
 ↳ 180,0 cm ↳ 75,4 cm ↳ 95,0 cm  
 ES – Eiche Sand *Sand oak*
- 92656 Stuhl R3 *Chair R3*  
 ↳ 56,0 cm ↳ 82,5 cm ↳ 59,0 cm  
 ES – Eiche Sand *Sand oak*
- 76502/ 76503 Korpuselement *Carcass element*  
 ↳ 63,2 cm ↳ 190,9 cm ↳ 39,6 cm  
 ES – Eiche Sand *Sand oak*  
 H4 – Chrom glänzend *Shiny chrome*
- 76702 Korpuselement *Carcass element*  
 ↳ 78,2 cm ↳ 190,9 cm ↳ 39,6 cm  
 ES – Eiche Sand *Sand oak*  
 P6 – Lack Taupe *Taupe lacquer*  
 H4 – Chrom glänzend *Shiny chrome*

## 24-25

- 68018 Wohnkombination *Living room combination*  
 ↳ 288,2 cm ↳ 217,3 cm ↳ 49,2 cm  
 P6 – Lack Taupe *Taupe lacquer*  
 ES – Eiche Sand *Sand oak*  
 H4 – Chrom glänzend *Shiny chrome*





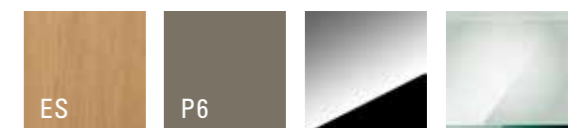

## 26-27

- 2x76457 Korpuselement *Carcass element*  
 ↳ 48,2 cm ↳ 120,5 cm ↳ 39,6 cm  
 P6 – Lack Taupe *Taupe lacquer*  
 ES – Eiche Sand *Sand oak*  
 H5 – Edelstahlfarbig *Stainless steel look*





## 28-29

- 33207 Schreibplatte mit Blende *Desk top with trim*  
 ↕ 120,0 cm ↕ 51,5 cm ↕ 49,2 cm  
 BK – Kernbuche *Beech heartwood* 
- 2× 75899 Wandbord *Wall shelf*  
 ↕ 120,0 cm ↕ 8,2 cm ↕ 20,6 cm  
 LW – Lack Weiß *White lacquer* 
- 92656 Stuhl R3 *Chair R3*  
 ↕ 56,0 cm ↕ 82,5 cm ↕ 59,0 cm  
 BK – Kernbuche *Beech heartwood* 
- 68017 Vitrine *Display cabinet*  
 ↕ 228,2 cm ↕ 190,9 cm ↕ 39,6 cm  
 BK – Kernbuche *Beech heartwood*   
 LW – Lack Weiß *White lacquer*   
 H4 – Chrom glänzend *Shiny chrome* 







 **Front + Karpus Front + Carcass**

- |  |   |   |                                       |
|--|---|---|---------------------------------------|
| LW Lack Weiß <i>white lacquer</i>          | LC Lack Crema <i>crema lacquer</i>      | R6 Lack Seidengrau <i>silk grey l.</i>    | S1 Lack Macchiata <i>macchiata l.</i> |
| R4 Lack Cashmere <i>cashmere l.</i>        | R3 Lack Olivgrau <i>olive grey l.</i>   | R5 L. Brillantgrau <i>diamond grey l.</i> | LY Lack Grau <i>grey lacquer</i>      |
| LH Lack Platingrau <i>platinum grey l.</i> | P6 Lack Taupe <i>taupe lacquer</i>      | LT Lack Terra <i>terra lacquer</i>        | R2 Lack Espresso <i>espresso l.</i>   |
| LZ Lack Ziegelrot <i>brick lacquer</i>     | DR Lack Dark Red <i>dark red l.</i>     | R8 Lack Oxidrot <i>oxide red l.</i>       | R7 Lack Rosewood <i>rosewood l.</i>   |
| S2 Lack Marill <i>marill lacquer</i>       | S5 L. Piniengrün <i>pine green l.</i>   | P9 Lack Agave <i>agave lacquer</i>        | P8 Lack Ocean <i>ocean lacquer</i>    |
| S4 L. Atlantikblau <i>atlantic blue l.</i> | S3 L. Schiefergrau <i>slate grey l.</i> | LG Lack Graphit <i>graphite lacquer</i>   | LS Lack Schwarz <i>black lacquer</i>  |

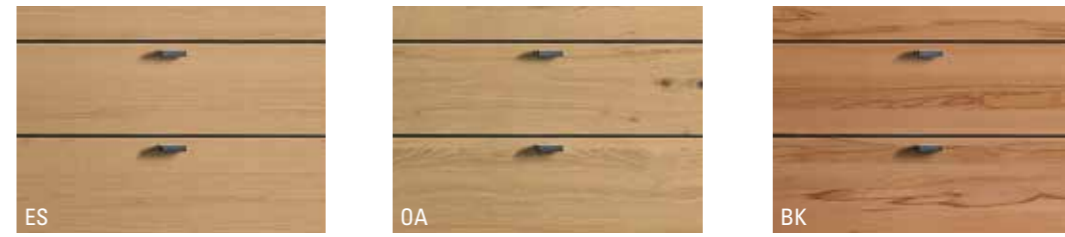
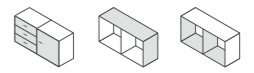
Alle Lacke auch in Hochglanz erhältlich  
All finishes are also available in high-gloss type



 **Front massiv Front solid wood**

- ES Eiche Sand massiv *Solid sand oak*  
OA Asteiche massiv *Solid knotty oak*  
BK Kernbuche massiv *Solid beech heartwood*

 **Korpus furniert Carcass veneered**

- ES Eiche Sand *Sand oak*  
OA Asteiche *Knotty oak*  
BK Kernbuche *Beech heartwood*

 **Innenausführung: Dekor Interior finish: Décor**

 **Griffe Handles**

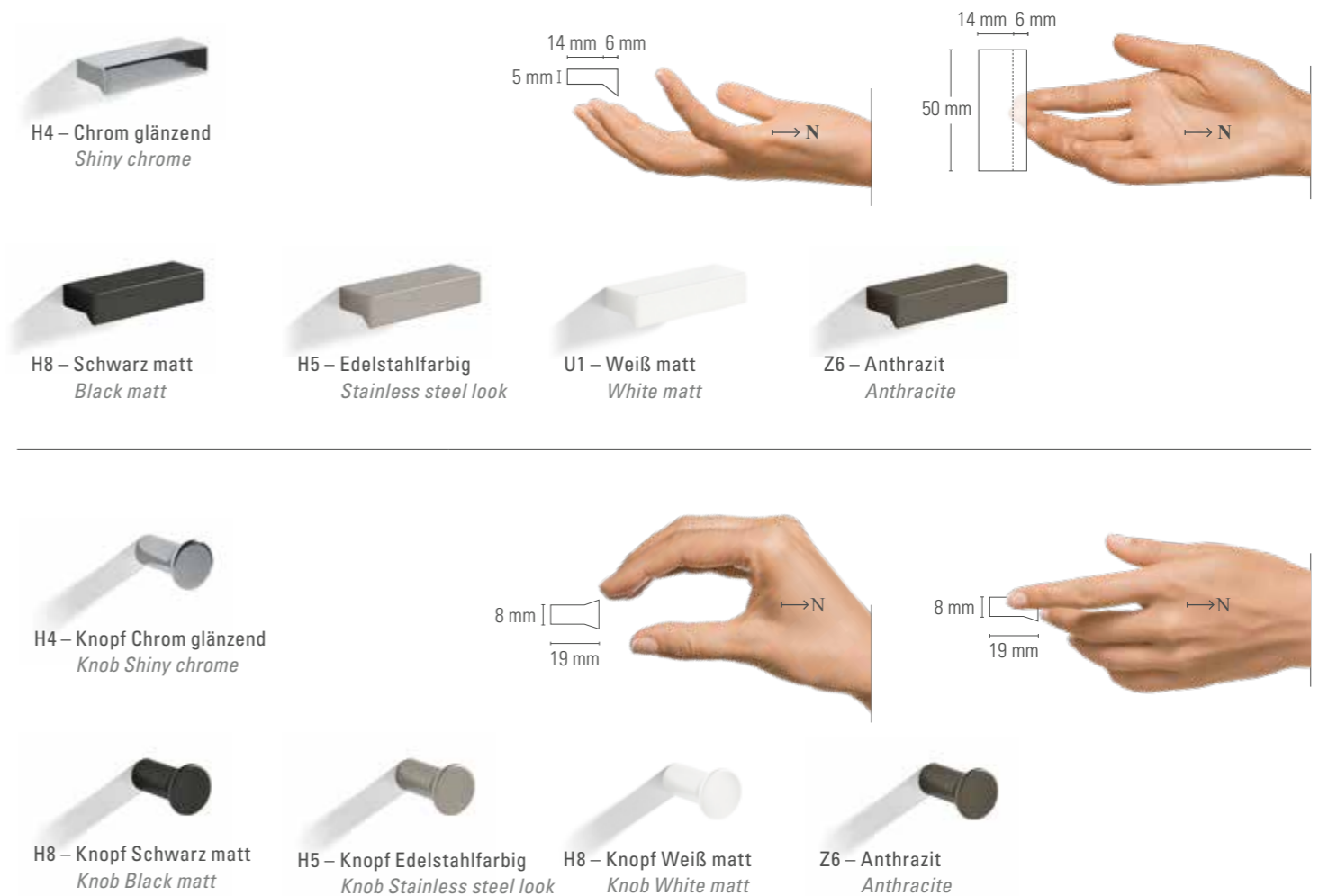



**Leder HERMES Leather HERMES**



**Vegane Lederalternative PURE Vegan leather alternative PURE**



**Velours CLOUD Velours CLOUD**

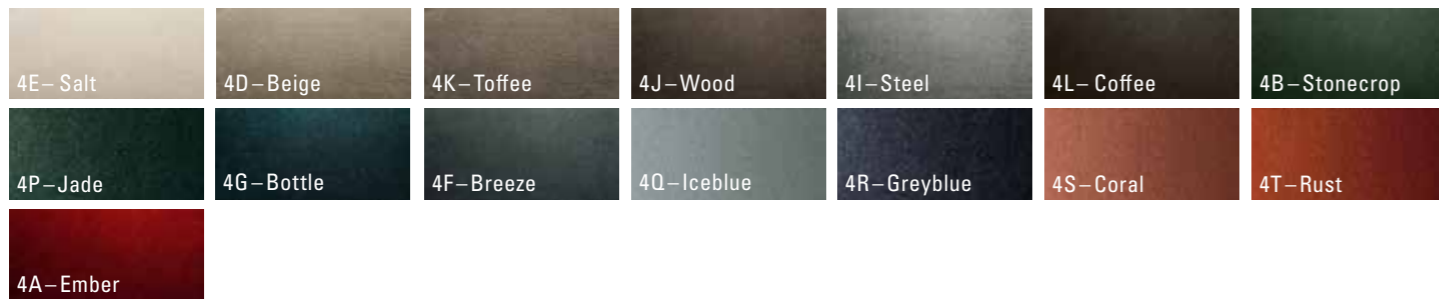

**Flachgewebe OCEAN Flat woven fabric OCEAN**

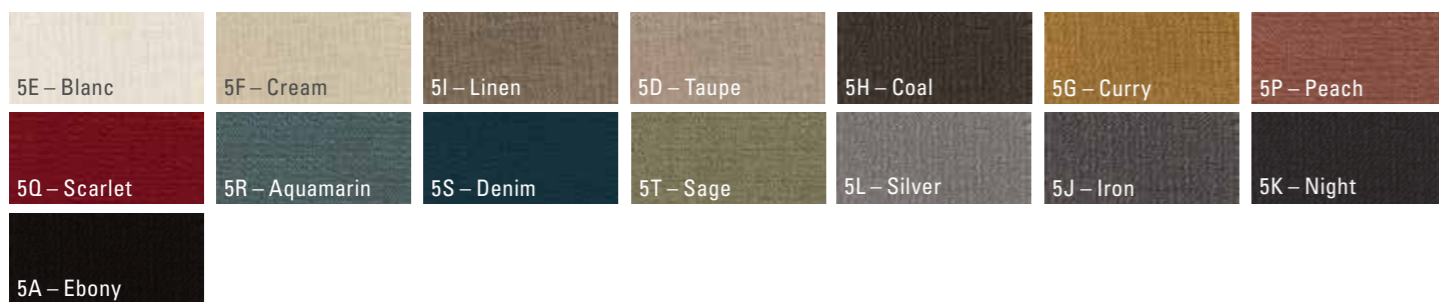

**Flachgewebe WILLOW Flat woven fabric WILLOW**



**Beispielartikel Sample article**

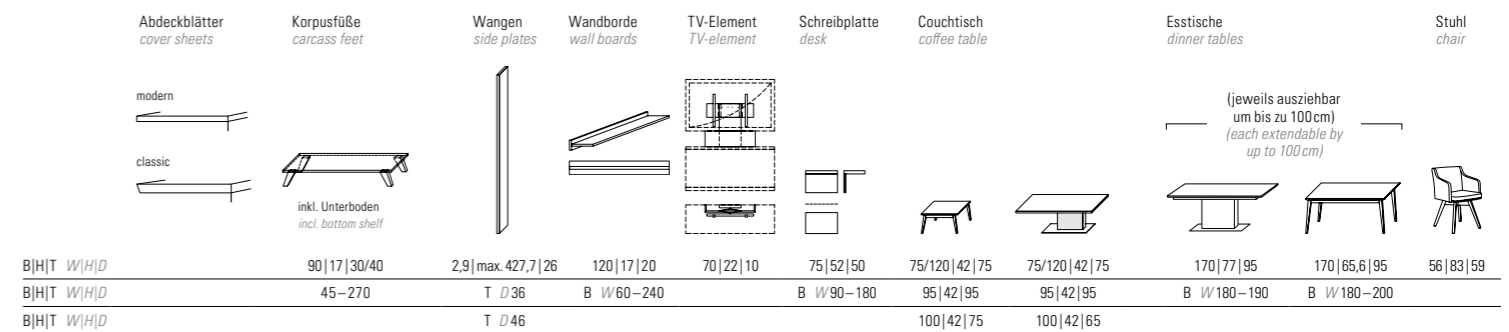
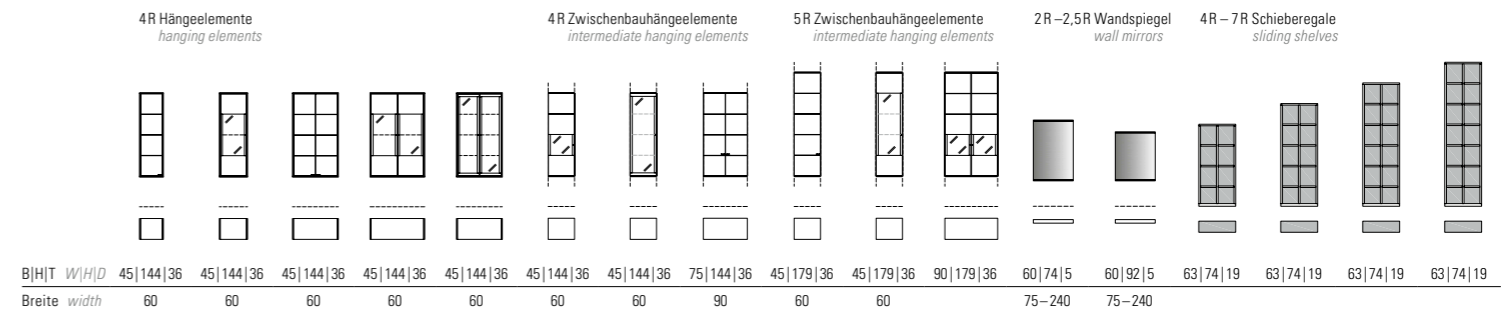
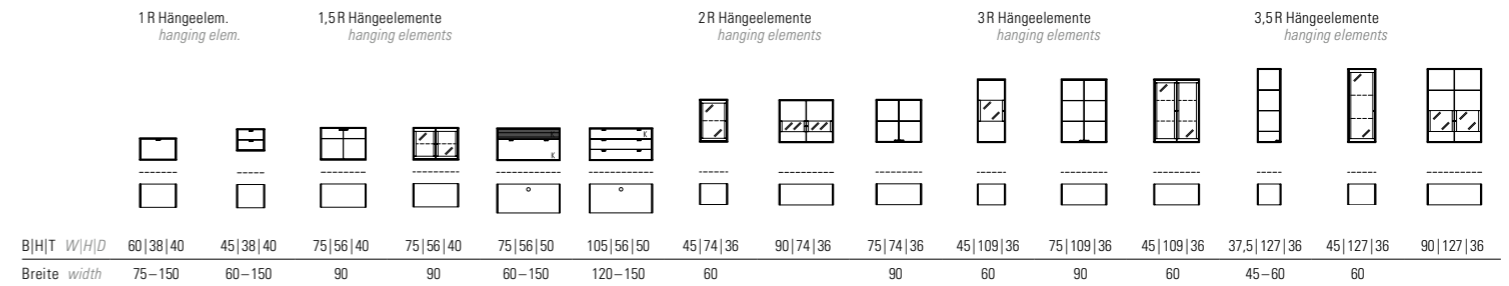
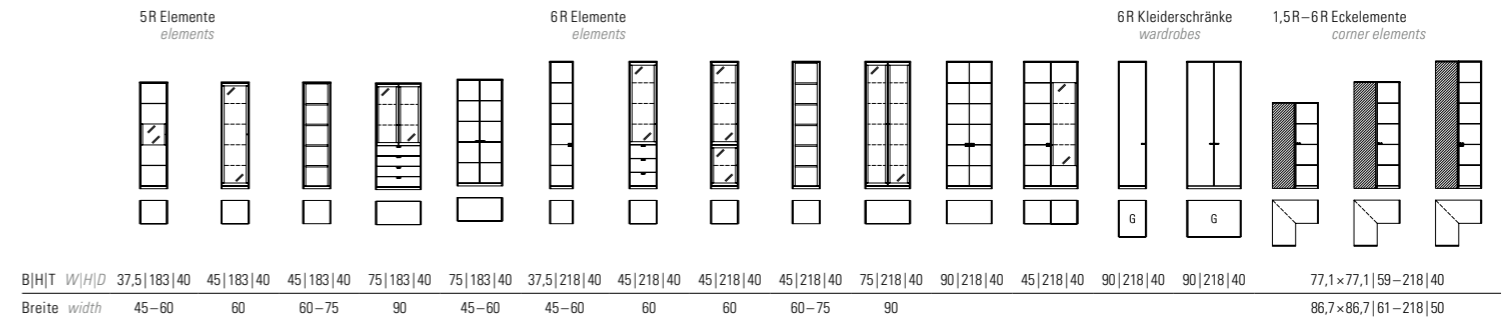
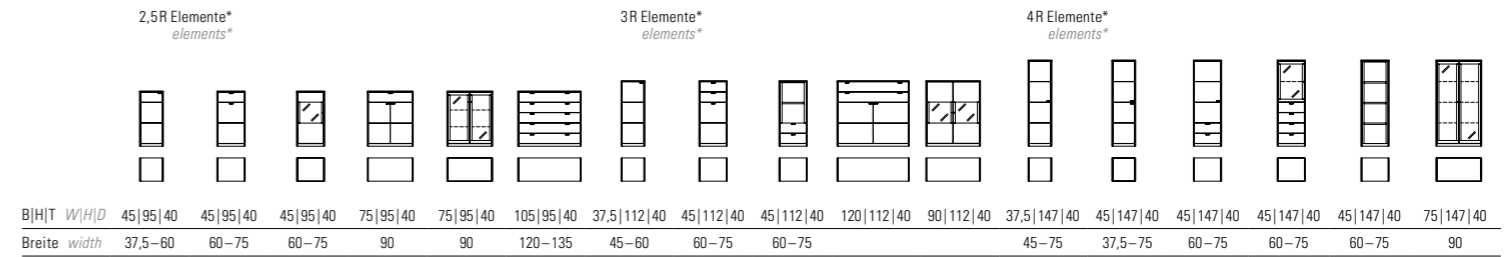
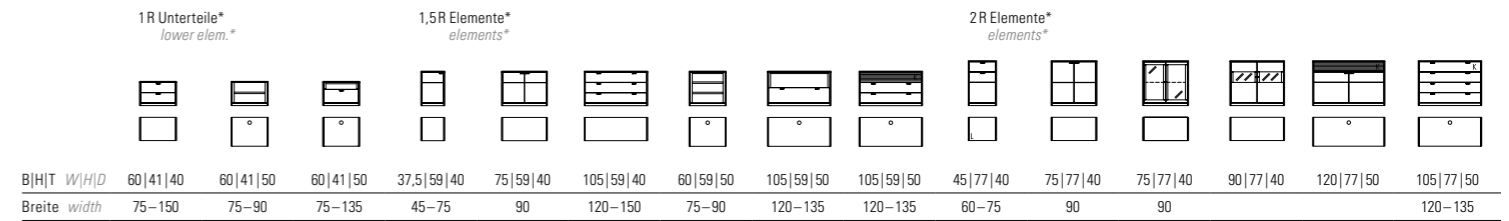

\* Auch in Komforttiefe 49,2 cm erhältlich • Alle Angaben in cm • Für einen vollständigen Überblick über alle lieferbaren Typen wenden Sie sich bitte an den Fachhandel • Abweichung im Design, in technischer Ausführung und Druckfehler vorbehalten; Grundlage aller Lieferungen ist unsere Preis-/Typenliste.  
 \* Also available in comfort depth of 49,2 cm • All specifications in cm • For a complete overview of all available types please contact an authorised dealer • Subject to changes in design, technical execution and printing errors.  
 All deliveries based on our price/type list.

**Komfort-Tablarauszug:** Mit dem Komfort-Tablarauszug können Sie wertvollen Stauraum in Sideboard und Schrank nutzen. Die Auszüge kommen Ihnen beim Öffnen der Tür entgegen, so dass Sie bequem von oben hineingreifen und Sachen verstauen können – damit gehören schlecht zugängliche Ecken im Schrank der Vergangenheit an.

*Comfort pull-out tray: The comfort pull-out tray enables you to use the valuable storage space in the sideboard and cupboard. The pull-outs move towards you as the door is opened so you can easily access them from above and put things away – making hard-to-reach cupboard corners a thing of the past.*



Von außen nicht zu erkennen: Die Komfort-Funktion wird beim Öffnen erkennbar. *Invisible from the outside: the comfort function becomes evident on opening.*



**Beleuchtung:** Sie können Ihr Möbel mit umfangreichen Beleuchtungsoptionen ausstatten: LEDs mit einer angenehmen Lichttemperatur in den Wandborden und Glaskanten sowie als Spots in den Vitrinen. Besonders komfortabel können Sie die verschiedenen Beleuchtungen mit der neuen 5-Kanal-Funkfernbedienung steuern.

*Lighting: You can choose from extensive lighting options for your furniture – LEDs with a pleasant light temperature in the wall boards and glass edges as well as spots in the cabinets. The new 5-channel radio remote control allows for a particularly comfortable control of the various lighting systems.*



Das Wandbord lässt sich stimmungsvoll in Szene setzen.\*  
*The wall board can be highlighted in a particularly atmospheric way.\**



Das LED-Lichtband erzeugt eine gleichmäßige warmweiße Lichtstimmung.\*  
*The LED lighting strip produces a uniform, warm white light mood.\**



\*Die Leuchten enthalten LED-Lampen, die innerhalb der Energieklasse E bis F liegen. Die LED-Lampen können nicht ausgetauscht werden.  
*\*The lamp is equipped with energy class E to F LEDs. The LEDs cannot be replaced.*

Mit der Funkfernbedienung steuern Sie ganz bequem die einzelnen Beleuchtungskomponenten in Ihren Möbeln.  
*It is easy to operate the individual lighting components of your furniture with the remote control.*

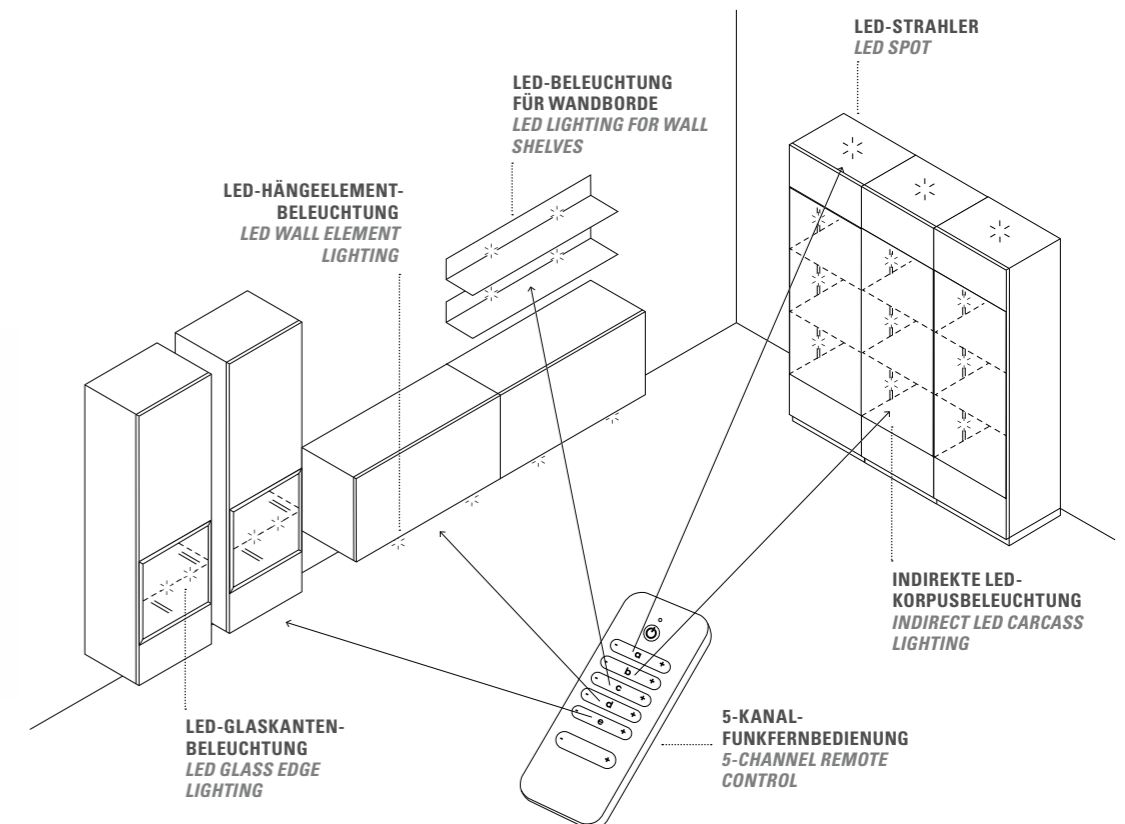

# Programm 2023 Programme 2023

